



1.50"(38.10mm)Single Digit 7 Segment Display

Features:

- *High segment intensity
- *Wide viewing angle
- *Range of colours
- *Black face White segment
- *Rohs compliant

Available option:

- *Alternative face and segment colour
- *Alternative font
- *Cropped terminal pins
- *Available emitting colour
- *Low current version

Electro/Optical Characteristics If=20mA Ta=25°C

Part Number Common Cathode	Part Number Common Anode	Emitting Colors	Peak Wavelength	Forward Voltage Vf		Luminous Intensity Iv	
				Typical	Max.	Min.	Typical
NFD-15011AS-11	NFD-15011BS-11	GaAlAs/GaAs Hi-Red	660	3.70	4.40	120.0	180.0
Units			nm	V		mcd	

Maximum Ratings Ta=25°C (Derate above 25°C)

Characteristic	Condition	Symbol	Hi-Red		Units
Pulse Forward Current	0.1 duty cycle 0.1ms Pulse width	I _{FP}	150		mA
DC Forward Current		I _F	25		mA
Reverse Current	V _r =5V	I _R	20		μA
Power Dissipature		P _D	60*15		mW
Operating Temperature		T _{OPR}	-40 to +80		°C
Storage Temperature		T _{TSG}	-40 to +85		°C
Lead soldering temperature	1.60mm from body maximum 3 seconds		260		°C

Checked	Chen N.H.	Approved	Jason Chen	Date	2006/06/04	PAGE 1 / 2
---------	-----------	----------	------------	------	------------	------------



1.50"(38.10mm)Single Digit 7 Segment Display

PACKAGE DIMENSION

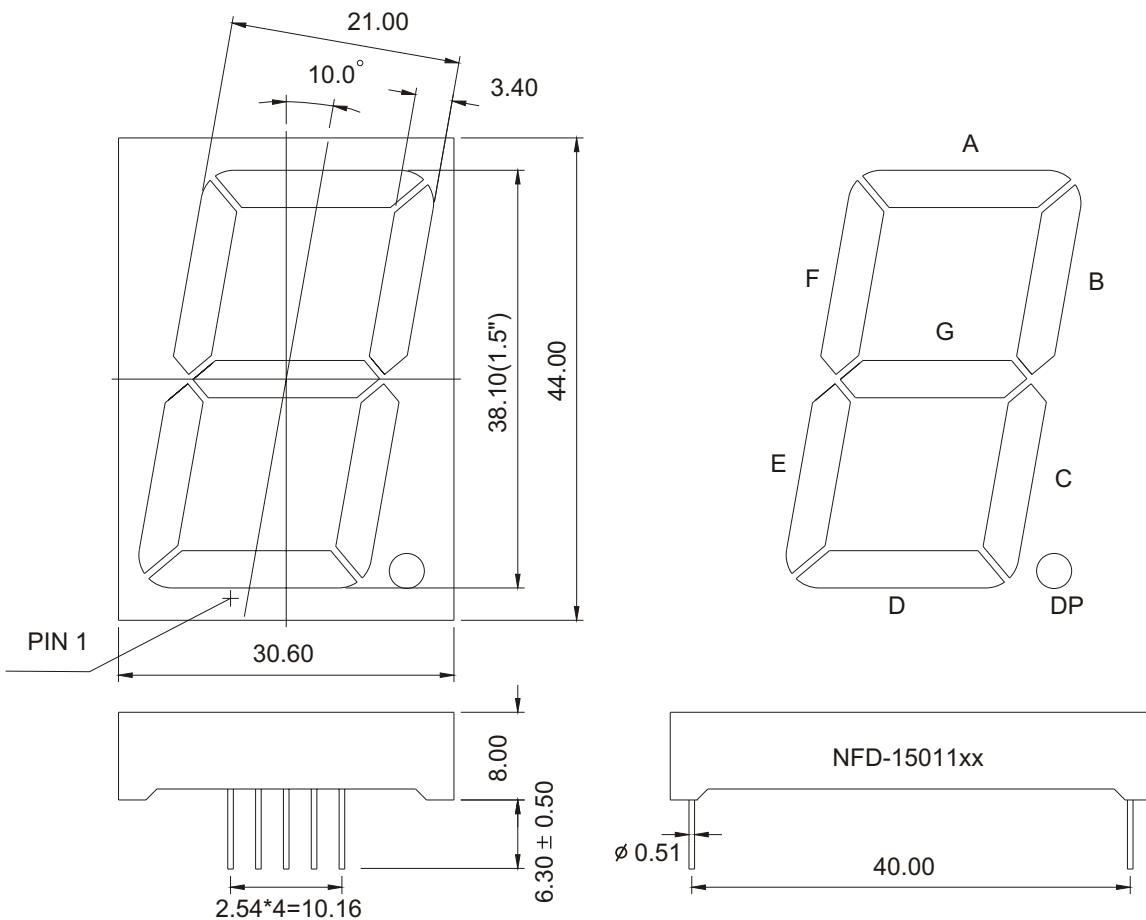

Tolerance $\pm 0.25\text{mm}$ unless stated

INTERNAL CIRCUIT DIAGRAM

Common Cathode NFD-15011Ax

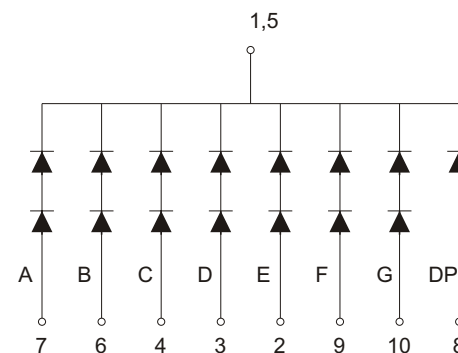

Common Anode NFD-15011Bx

